

Outline Drawing

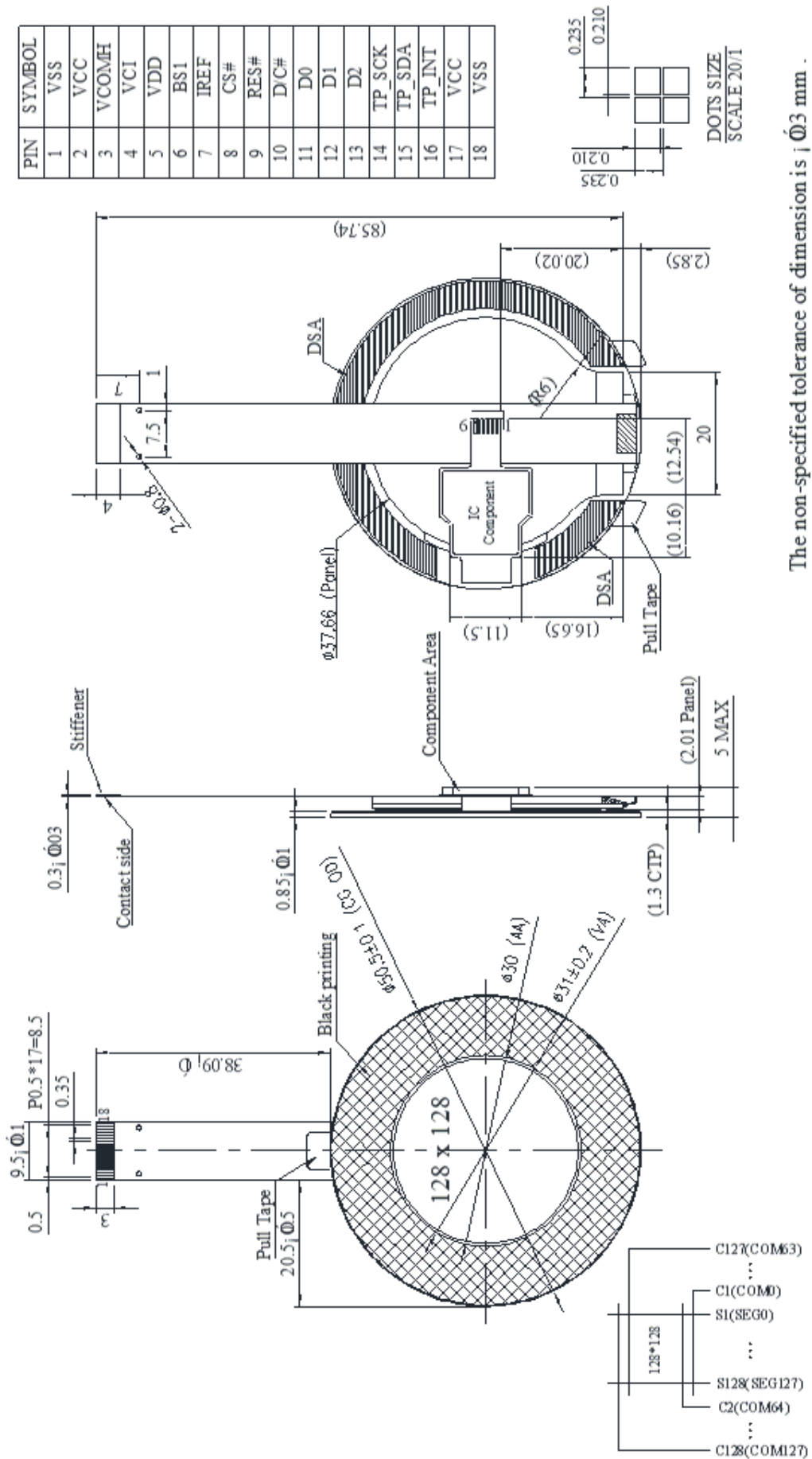

The non-specified tolerance of dimension is ± 0.3 mm .